

EVP SERIES MOUSE VALVES

2-WAY PROPORTIONAL VALVES



- Flow proportional to input current
- Fast response and long life
- Small, compact design
- Single moving part for low friction and wear
- Five orifice sizes
- Three connection styles
- Two mounting types

OPERATING PRESSURE

The EVP proportional valve can be calibrated for pressures less than the maximum pressure shown. Lower pressures may be substituted in increments of 5 psig, and will be used for calibration. For pressures less than 5 psig, call **877-245-6247**.

Note: Voltage, orifice, and pressure are determined by the part number (see p. 56).

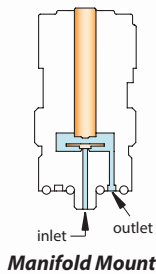
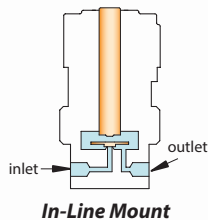

APPLICATIONS

- Analytical Instruments
- Blood pressure monitoring
- Precise pressure control
- Patient simulators
- Gas controllers
- Mass flow control
- Gas chromatography
- Respirators/ventilators

The EVP series proportional control valves combine the features of the existing EV series valve—long life, low power, and Clippard’s reputation for high quality components—with the additional capability for proportional control. The EVP series valve provides air or gas flow control and varies the output flow based on the current input to the solenoid.

Controllability and overall value are the main features of the EVP proportional valve series. The consistent gain (see chart) of this valve provides a high degree of control for many applications. The valve may be controlled using DC current, open or closed-loop control, and even PWM (pulse width modulation) to cover a broad range of applications.

Medium	Clean, dry air or inert gases
Power Consumption	1.9 watts @ 73°F 2.3 watts max.
Temp. Range	32 to 120°F
Ports	#10-32 Female (in-line) #10-32 Male stud (manifold) <i>See p. 20 for manifold options</i>
Seal Material	Nitrile standard FKM, EPDM, and others available
Max. Hysteresis	10% of full current
More Details	clippard.com/link/evp

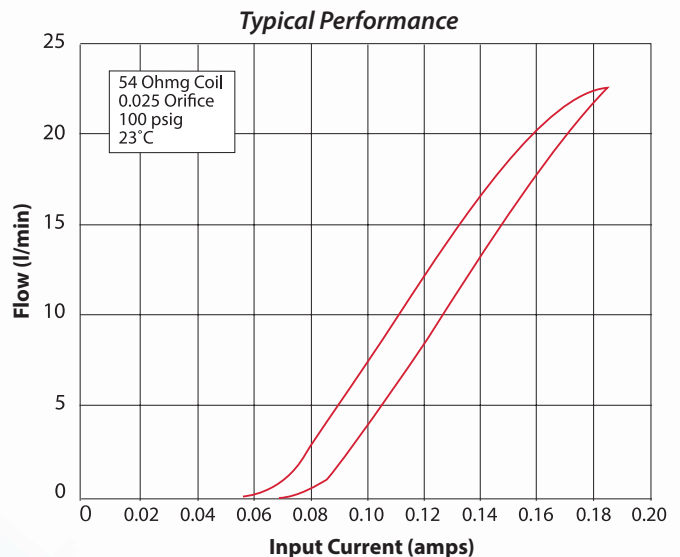

EVP Series Proportional Mouse Valves

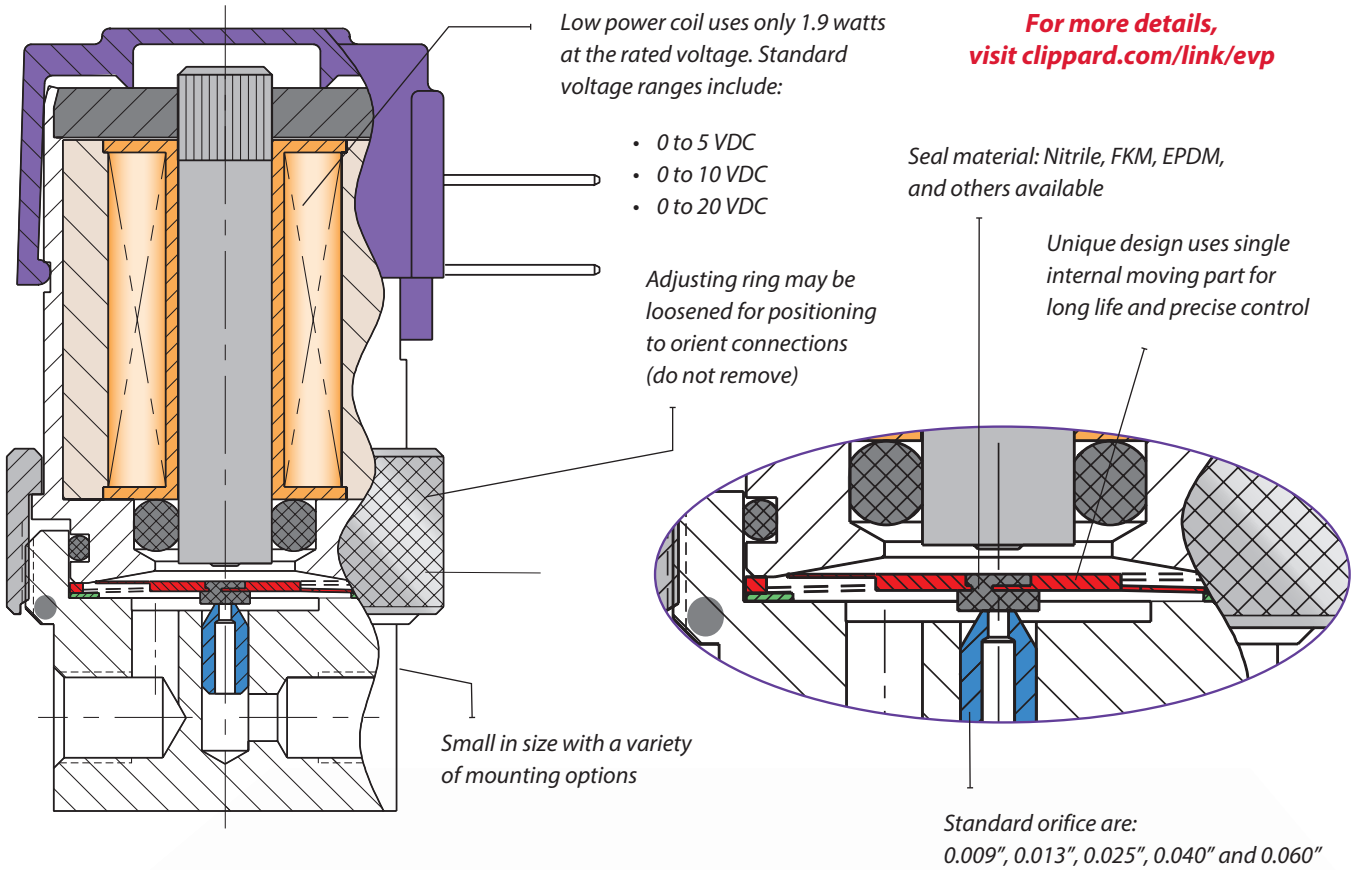

PROPORTIONAL VALVES

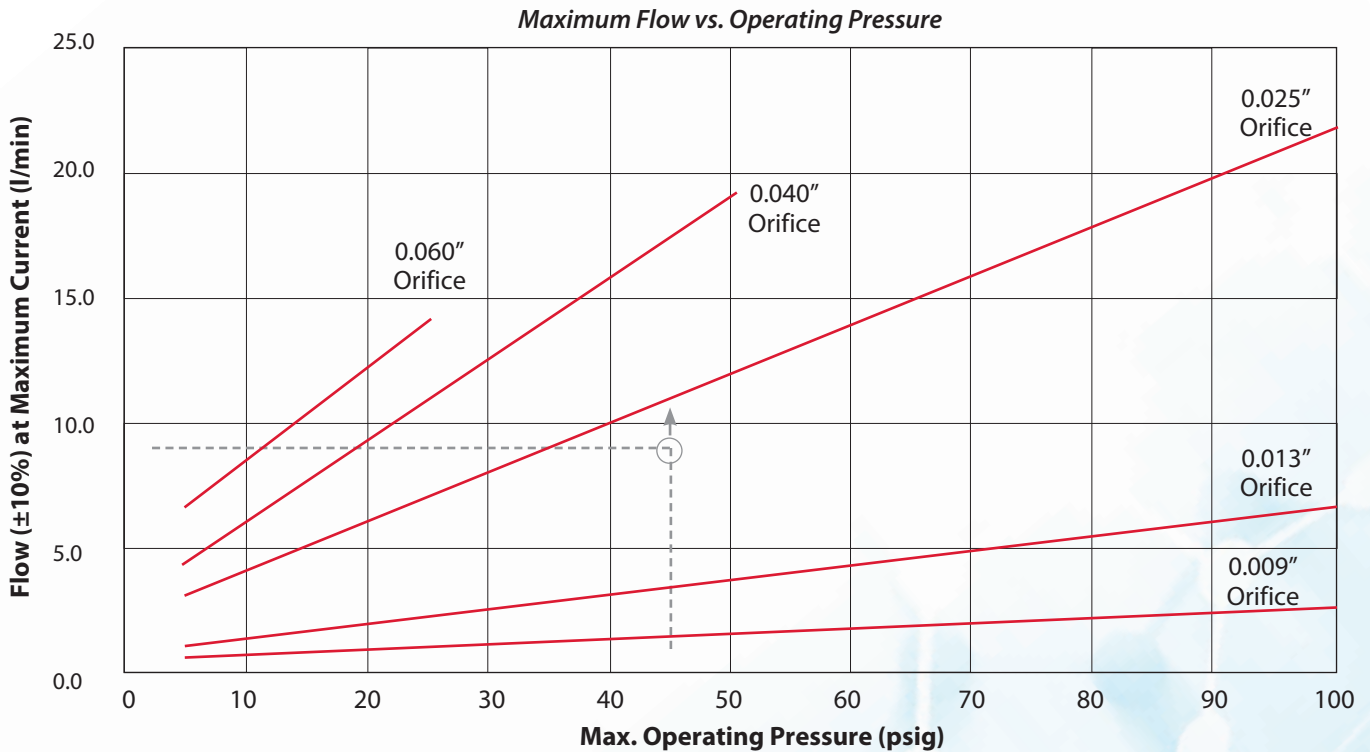

To determine the correct orifice required, locate the colored line immediately above the flow/pressure intersection
 Example: 9 slpm required at 45 psig inlet. This example leads to a "-2545" valve (0.025" nozzle, 45 psig).

EVP SERIES MOUSE VALVES

2-WAY PROPORTIONAL VALVES, IN-LINE & MANIFOLD MOUNT

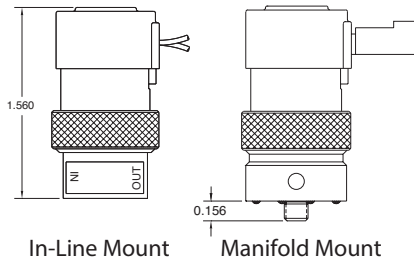

		Voltage		Base Part No.	
		5VDC	10VDC	In-Line Mount	Manifold Mount
	 0.025" Pin Connector	•	•	EC-P-05-□□□□	EC-PM-05-□□□□
	 Spade Terminals		•	EC-P-10-□□□□	EC-PM-10-□□□□
				•	EC-P-20-□□□□
	 Spade Terminals	•	•	ET-P-05-□□□□	ET-PM-05-□□□□
			•	ET-P-10-□□□□	ET-PM-10-□□□□
	 Wire Leads Side (Radial)	•	•	EV-P-05-□□□□	EV-PM-05-□□□□
			•	EV-P-10-□□□□	EV-PM-10-□□□□
			•	EV-P-20-□□□□	EV-PM-20-□□□□

Operating Range & Orifice

When selecting your valve, there are many variables to choose from.

To choose the best valve for your application, focus on:

1. The control signal
2. Valve orifice
3. Operating pressure

Consult factory to discuss availability of non-standard voltages and other customization options.

Although the valves are listed by voltage, their flow is proportional to the current. It is crucial to specify and use a valve set to your operating pressure to assure optimal performance for your exact requirements. Proportional flow is achieved by varying the current input to the valve.

The EVP valve can be calibrated for pressures less than the maximum shown. Lower pressures may be substituted in increments of 5 psig, and will be used for calibration. The pressures shown are standard options. For pressures less than 5 psig or greater than the maximum pressure listed, please consult Clippard.

CONTROL SIGNAL

Nominal Voltage Range @ 72°F (VDC)	Input Current Range (amps)	Coil Resistance @ 72°F (ohms)	Max. Voltage Required (VDC)
0 to 5	0 to 0.370	13.5	6.2
0 to 10	0 to 0.185	54	12.4
0 to 20	0 to 0.092	218	24.8

Do not exceed input current range

STANDARD ORIFICES & FLOW

Orifice	Max. Flow (l/min)	Part No. Code	Max. Pressure
0.009"	2.7 ±10%	09	100 psig
0.013"	6.7 ±10%	13	100 psig
0.025"	22.0 ±10%	25	100 psig
0.040"	18.7 ±10%	40	50 psig
0.060"	14.0 ±10%	60	25 psig

Note: Max. flow is measured at max. pressure

ORDERING INFORMATION

Base Part No. → Options

See chart above

Orifice* → Options

09 0.009" dia. Options

13 0.013" dia. **Max. Pressure (5 psig to 100 psig)**

25 0.025" dia. Options

40 0.040" dia. **In increments of 5, from 05 to 95**

60 0.060" dia. **A0 100 psig**

Example Part Number: EC-P-05-0905-V

(blank) Nitrile (standard)
E EPDM¹
V FKM¹

¹Min. order quantity required for EPDM or FKM seals

*See max. pressure in **Standard Orifices & Flow** chart above

EVP SERIES MOUSE VALVE DRIVER

PROPORTIONAL VALVE DRIVER



- Plug-and-play interface between Clippard's EVP and DVP series valves and PLCs or other controls
- Linearized valve response right "out of the box"
- Three selectable valve output ranges
- Five signal inputs to choose from
- Easy integration with existing machine controls
- User-adjustable parameters
- Automatic temperature compensation to maintain constant current
- Two configuration options: Stand-alone PCB or enclosed in housing
- Compact size

Power Requirements

Power input requirements are specified as supply voltage ranges for each EVP or DVP valve. Supplying voltages outside of these ranges may result in valve malfunctioning. Power requirements are determined by the valve voltage specification.

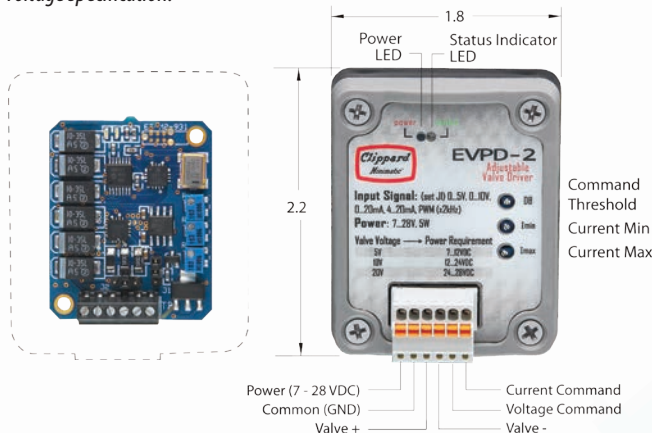
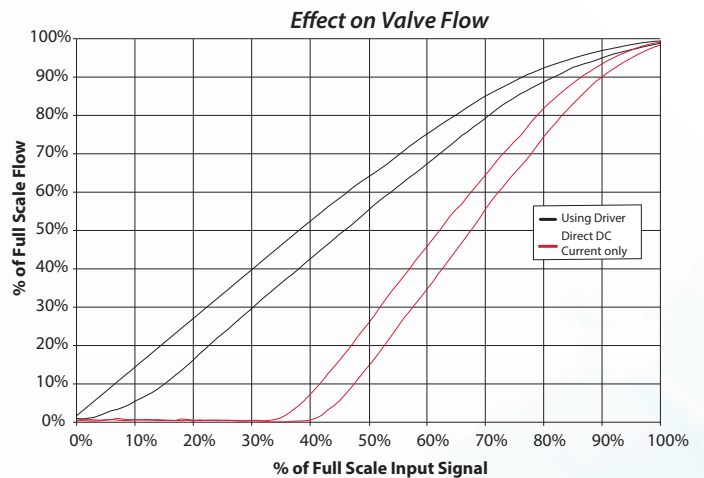

Figure 1: Effect of Driver Output on EVP or DVP Flow

The EVPD Proportional Valve Driver fast-tracks valve control applications. This product is ideal for laboratories and OEM product development, and can be customized to fit OEM applications including control parameters. The EVPD produces driver current for Clippard's EVP or DVP series valves proportional to input control signals.

Power Requirement	7 to 28 VDC @ 5 watt
Input Impedance	200 kΩ
Command Set-Point Signal Type	Selectable: 0 to 5 VDC, 0 to 10 VDC, 0 to 20 mA, 4 to 20 mA, PWM @ ≥ 2 kHz duty cycle
Adjustments	Min. drive current, max. drive current, command deadband
LED Indicators	Power, activity status, and faults
Output	0 to 0.4 (selectable range)
Temperature Range	0 to 155°F
Size	Open card: 1.5" x 1.3" x 0.4" unmounted Enclosed: 2.2" x 1.8" x 0.7" excluding DIN clip
More Details	clippard.com/link/evpd



EVP Valve Type	Input Voltage Range	EVPD Max. Output*
0 to 5 VDC	7 to 12 VDC	400 mA
0 to 10 VDC	12 to 28 VDC	200 mA
0 to 20 VDC	14 to 28 VDC	100 mA

*See EVP/DVP valve current requirements

Part No.	Description
EVPD-2	EVPD Driver Assembly in Enclosure
EVPD-1	EVPD Driver Board
EVPD-2DIN	DIN Rail Mounting Clip (shown at right) with screws

